

PQM60W2V

Proyector de Módulo Led 60W

Producto



Dimensiones

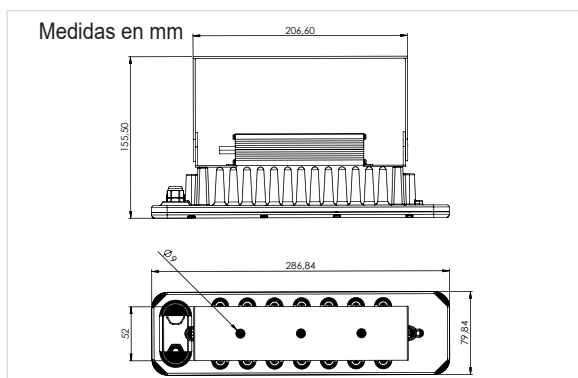

Datos Técnicos

Entrada:	110~250Vac 50/60Hz
Potencia:	60W
Nº de LEDs:	20 chips XT-E de CREE
Factor Potencia:	>0.95
Eficiencia Luminica:	102 lm/w
Potencia LED:	3W
Flujo Luminoso:	6120 lm (BF) 6005 lm (BN) 5896 lm (BC)
Intensidad Luminosa:	5036cd
Grado de IK:	09
Grado de IP:	IP65
Temp. Trabajo:	-20°C +50°C
Nº Conmutaciones:	30.000
Certificaciones:	CE, RoHS
Eficiencia Energética:	A+
Vida útil:	50.000h (L70:B50)
Regulación:	Sí, (Opcional)
Peso:	1080 gramos

Datos Fotométricos

Ángulo de apertura =45°, 60°, 120°
Flujo Luminoso =6120 lm
Tª de color CCT =5700K (BF)
CRI =>80

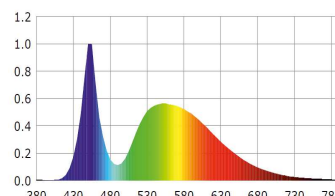

Luz Fría 60°

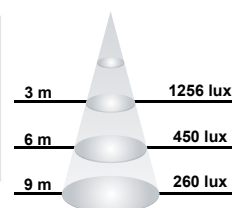

Ángulo de apertura =45°, 60°, 120°
Flujo Luminoso =6005 lm
Tª de color CCT =4000K (BN)
CRI =>80

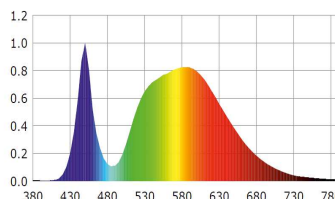

Luz Neutra 60°

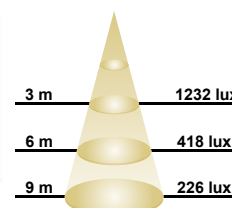

Ángulo de apertura =45°, 60°, 120°
Flujo Luminoso =5896 lm
Tª de color CCT =3000K (BC)
CRI =>80

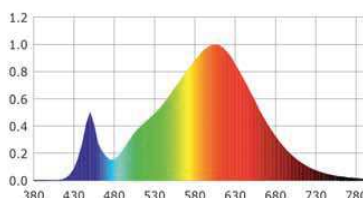

Luz Cálida 60°

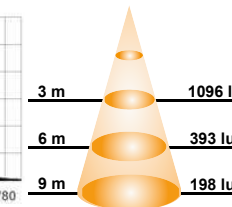

Curva de Distribución Luminosa

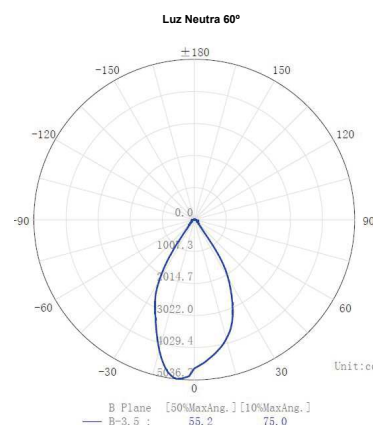

Chip utilizado

