

## P60X60UGR

Panel Led de 60x60 de 40W bajo UGR

### Producto



### Dimensiones

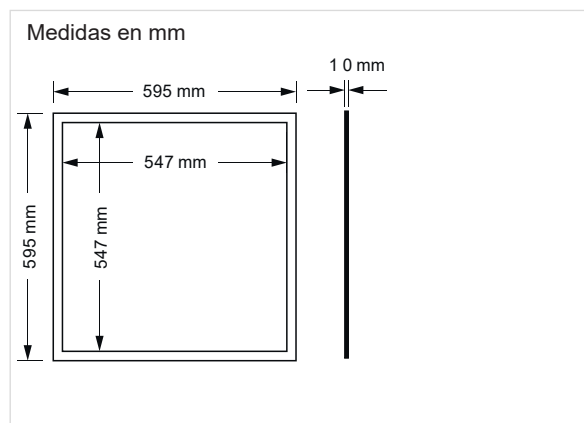

### Datos Técnicos

Entrada:	AC 220~240V 50/60Hz
Potencia:	40W
Nº de LEDs:	204 chips SMD 4014
Factor Potencia:	>0.95
Eficiencia Lumínica:	83 lm/w
Potencia LED:	0.19W
Flujo Lumínico:	3350 lm (BF) 3300 lm (BN) 3230 lm (BC)
Intensidad Lumínica:	1547cd
Índice UGR:	<19
Grado de IP:	IP20
Temp. Trabajo:	-20°C +40°C
Nº Conmutaciones:	15.000
Certificaciones:	CE, RoHS
Eficiencia Energética:	A+
Vida útil:	30.000h (L70:B10)
Regulación:	Si, DM250-700mA (Opcional)
Peso:	4015 gramos

### Datos Fotométricos

**Ángulo de apertura** =120°  
**Flujo Lumínico** =3350 lm  
**Tª de color CCT** =6000K (BF)  
**CRI** =>80

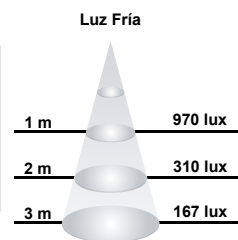
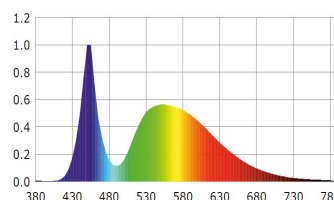

**Ángulo de apertura** =120°  
**Flujo Lumínico** =3300 lm  
**Tª de color CCT** =4000K (BN)  
**CRI** =>80

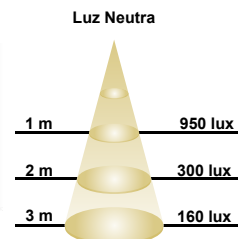
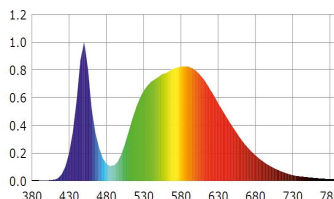

**Ángulo de apertura** =120°  
**Flujo Lumínico** =3230 lm  
**Tª de color CCT** =3000K (BC)  
**CRI** =>80

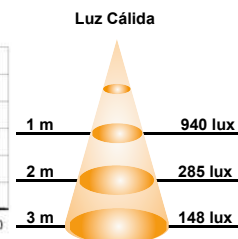
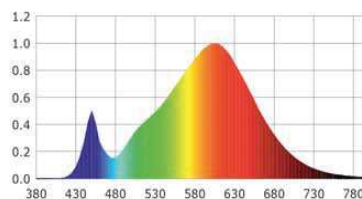

Curva de Distribución Lumínica

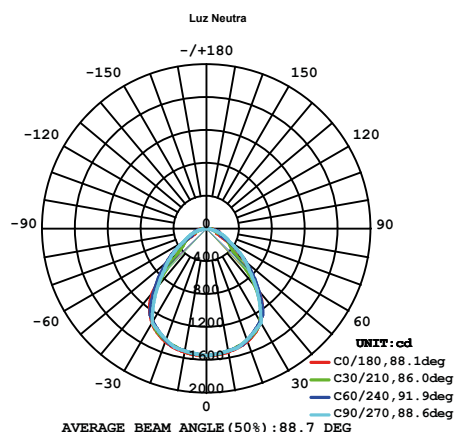

Chip utilizado

EPistar



ThreeLine TECHNOLOGY