

OFD20W

DownLed Redondo empotrable 20W bajo UGR

Acabados:



Opcional:



Producto



Dimensiones

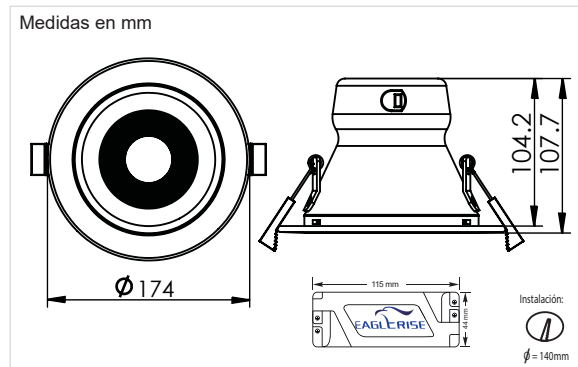

Datos Técnicos

Entrada:	220~240Vac 50/60Hz
Potencia:	20W
Nº de LEDs:	33 chips SMD2835
Factor de Potencia:	>0.90
Eficiencia Lumínica:	85 lm/w
Potencia LED:	0,60W
Flujo Lumínico:	1700 lm (BF) 1600 lm (BN) 1500 lm (BC)
Intensidad Lumínica:	2977cd
Índice UGR:	<16
Grado de IP:	IP20
Temp. Trabajo:	-10°C +40°C
Nº Conmutaciones:	30.000
Certificaciones:	CE, RoHS
Eficiencia Energética:	A+
Vida útil:	50.000h (L70:B10)
Regulación:	Si, (Opcional DM250-700mA)
Peso:	285 gramos

Datos Fotométricos

Ángulo de apertura =60°
Flujo Lumínico =1700 lm
Tª de color CCT =6000K (BF)
CRI =>80

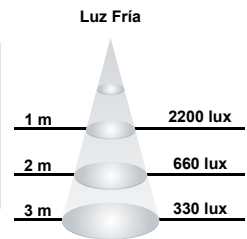
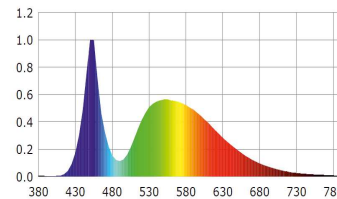

Ángulo de apertura =60°
Flujo Lumínico =1600 lm
Tª de color CCT =4000K (BN)
CRI =>80

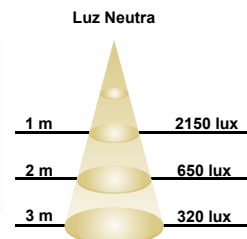
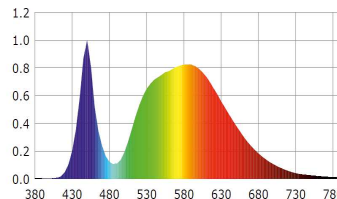

Ángulo de apertura =60°
Flujo Lumínico =1500 lm
Tª de color CCT =3000K (BC)
CRI =>80

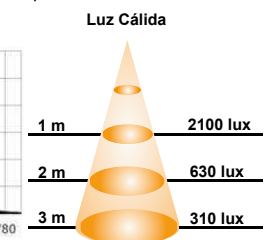
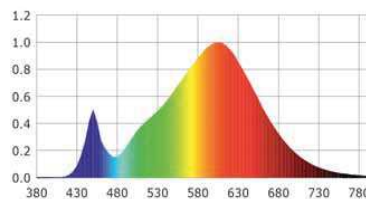

Curva de Distribución Lumínica

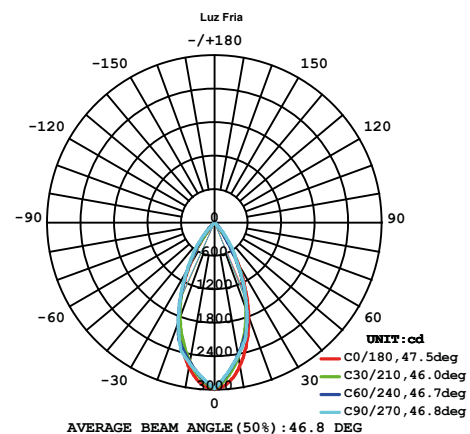

Chip utilizado

EPistar



ThreeLine TECHNOLOGY