

## OFD10W

DownLed empotrable 10W bajo UGR

Acabados:



Opcional:



### Producto



### Dimensiones

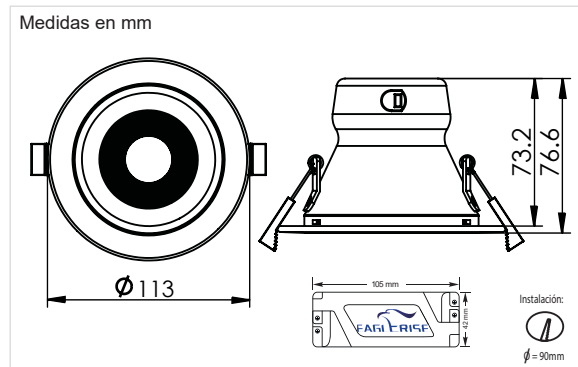

### Datos Técnicos

Entrada:	220~240Vac 50/60Hz
Potencia:	10W
Nº de LEDs:	21 chips SMD2835
Factor de Potencia:	>0.90
Eficiencia Lumínica:	85 lm/w
Potencia LED:	0,47W
Flujo Lumínico:	850 lm (BF) 840 lm (BN) 830 lm (BC)
Intensidad Lumínica:	1219cd
Índice UGR:	<16
Grado de IP:	IP20
Temp. Trabajo:	-10°C +40°C
Nº Conmutaciones:	30.000
Certificaciones:	CE, RoHS
Eficiencia Energética:	A+
Vida útil:	50.000h (L70:B10)
Regulación:	Sí, (Opcional DM250-700mA)
Peso:	185 gramos

### Datos Fotométricos

Ángulo de apertura =60°  
Flujo Lumínico =850 lm  
Tª de color CCT =6000K (BF)  
CRI =>80

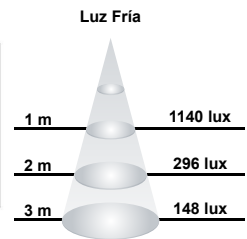
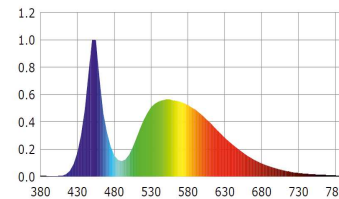

Ángulo de apertura =60°  
Flujo Lumínico =840 lm  
Tª de color CCT =4000K (BN)  
CRI =>80

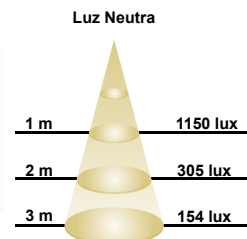
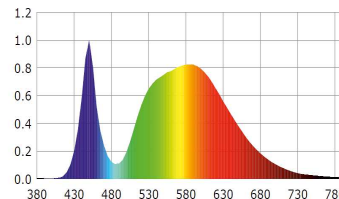

Ángulo de apertura =60°  
Flujo Lumínico =830 lm  
Tª de color CCT =3000K (BC)  
CRI =>80

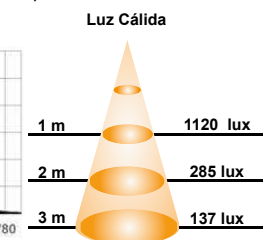
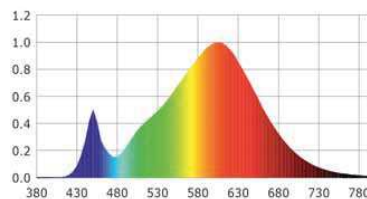

Curva de Distribución Lumínica

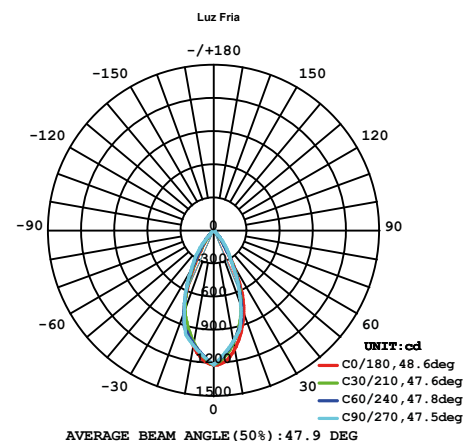

Chip utilizado

EPistar



ThreeLine TECHNOLOGY