

HBO300W

Campana LED Redonda 300W

Producto



Dimensiones

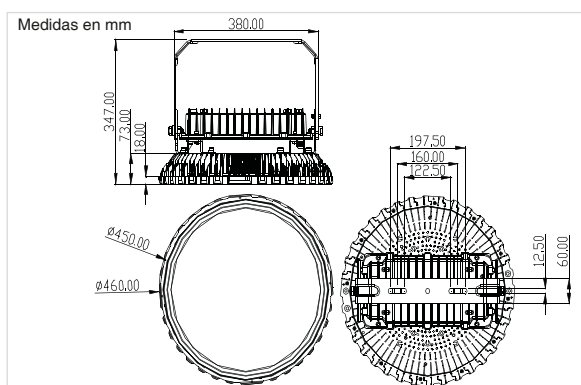

Datos Técnicos

Entrada:	110~240Vac 50/60Hz
Potencia:	300W
Nº de LEDs:	448 chips SMD3030 PHILIPS
Factor Potencia:	>0.90
Eficiencia Lumínica:	125 lm/w
Potencia LED:	0.65W
Flujo Luminoso:	37500 lm (BF) 37200 lm (BN) 37000 lm (BC)
Intensidad Lumínica:	11933cd
Grado de IP:	IP65
Temp. Trabajo:	-20°C +50°C
Nº Conmutaciones:	30.000
Certificaciones:	CE, RoHS
Eficiencia Energética:	A+
Vida útil:	50.000h (L70:B10)
Regulación:	Si, MEAN WELL (Opcional)
Peso:	3,700 gramos

Datos Fotométricos

Ángulo de apertura =30°, 90°, 120°
Flujo Luminoso =37500 lm
Tª de color CCT =5500K (BF)
CRI =>80

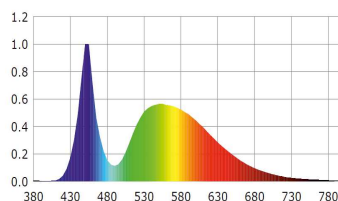

Luz Fría

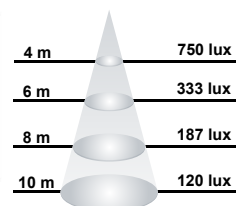

Ángulo de apertura =30°, 90°, 120°
Flujo Luminoso =37200 lm
Tª de color CCT =4000K (BN)
CRI =>80

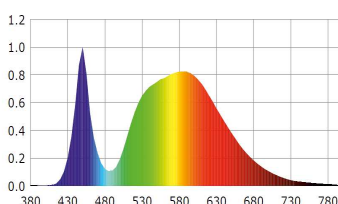

Luz Neutra

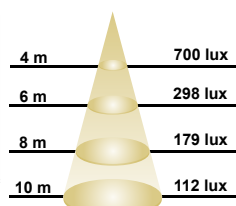

Ángulo de apertura =30°, 90°, 120°
Flujo Luminoso =37000 lm
Tª de color CCT =3000K (BC)
CRI =>80

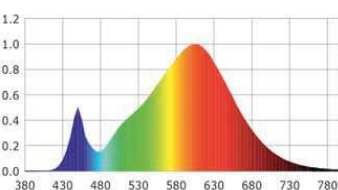

Luz Cálida

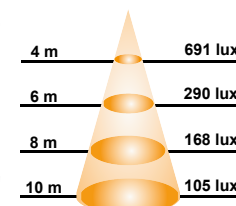

Curva de Distribución Lumínica

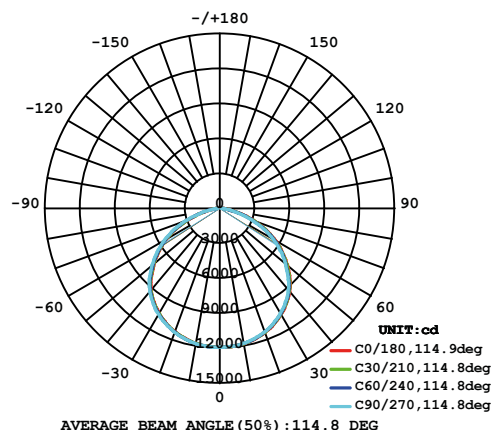

Chip utilizado

PHILIPS



ThreeLine TECHNOLOGY