

ECO25WIP65

DownLed Eco Redondo de 25W en IP65

Producto



Dimensiones

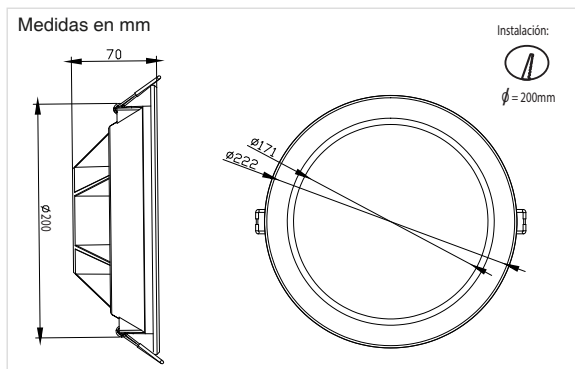

Datos Técnicos

Entrada:	110~240Vac 50/60Hz
Potencia:	25W
Nº de LEDs:	54 chips SMD2835
Factor Potencia:	>0.90
Eficiencia Lumínica:	92 lm/w
Potencia LED:	0.46W
Flujo Lumínico:	2290 lm (BF) 2250 lm (BN) 2200 lm (BC)
Intensidad Lumínica:	761 cd
Grado de IP:	IP65
Temp. Trabajo:	-20°C +40°C
Nº Conmutaciones:	30.000
Certificaciones:	CE, RoHS
Eficiencia Energética:	A+
Vida útil:	30.000h (L70:B10)
Peso:	440 gramos

Datos Fotométricos

Ángulo de apertura =120°
Flujo Lumínico =2290 lm
Tª de color CCT =5700K (BF)
CRI =>80

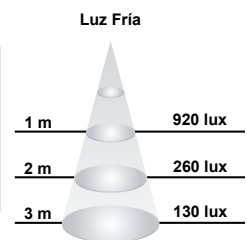
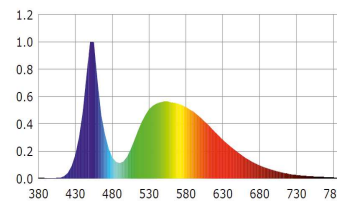

Ángulo de apertura =120°
Flujo Lumínico =2250 lm
Tª de color CCT =4000K (BN)
CRI =>80

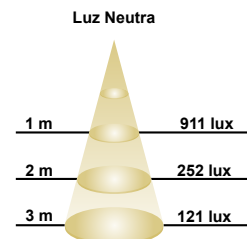
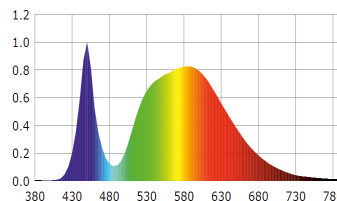

Ángulo de apertura =120°
Flujo Lumínico =2200 lm
Tª de color CCT =3000K (BC)
CRI =>80

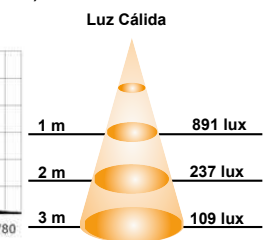
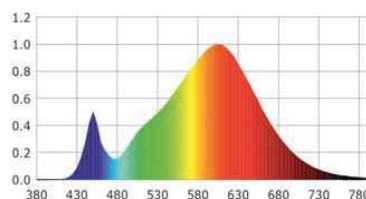

Curva de Distribución Lumínica

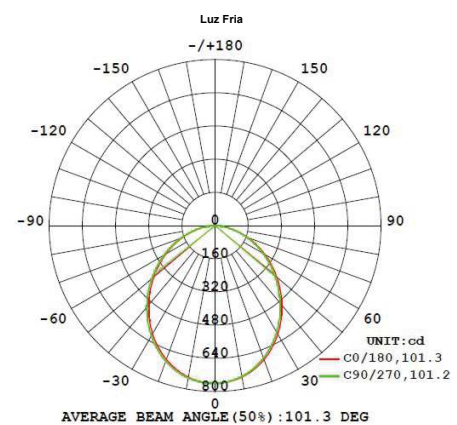

Chip utilizado

EPISTAR



ThreeLine
 TECHNOLOGY