

DL25WUGRIP65

DownLed Redondo 25W bajo UGR

Opciones:



Producto



Dimensiones

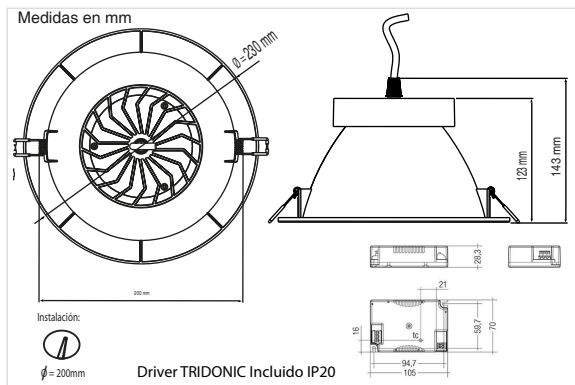

Datos Técnicos

Entrada:	220~240Vac 50/60Hz
Potencia:	25W
Nº de LEDs:	60 chips SMD2016 EPISTAR
Factor Potencia:	>0.90
Eficiencia Lumínica:	80 lm/w
Potencia LED:	0.40W
Flujo Luminoso:	2000 lm (BF) 1950 lm (BN) 1900 lm (BC)
Intensidad Lumínica:	1010cd
Grado de IP:	IP65
Grado de UGR:	<19
Temp. Trabajo:	-10°C +40°C
Nº Conmutaciones:	30.000
Certificaciones:	CE, RoHS
Eficiencia Energética:	A+
Vida útil:	50.000h (L70:B10)
Regulación:	Si, DM250-700mA (Opcional)
Peso:	550 gramos

Datos Fotométricos

Ángulo de apertura =100°
 Flujo Luminoso =2000 lm
 Tª de color CCT =6500K (BF)
 CRI =>80

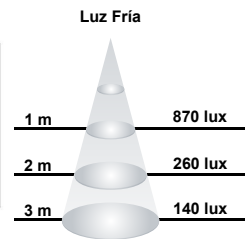
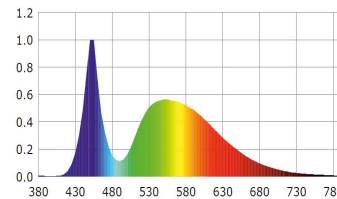

Ángulo de apertura =100°
 Flujo Luminoso =1950 lm
 Tª de color CCT =4000K (BN)
 CRI =>80

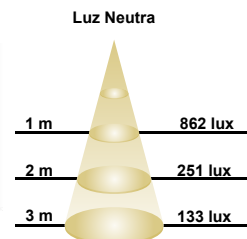
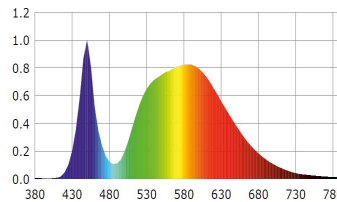

Ángulo de apertura =100°
 Flujo Luminoso =1900 lm
 Tª de color CCT =3000K (BC)
 CRI =>80

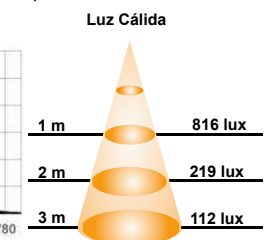
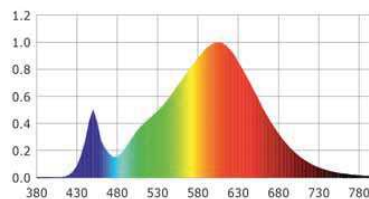

Curva de Distribución Lumínica

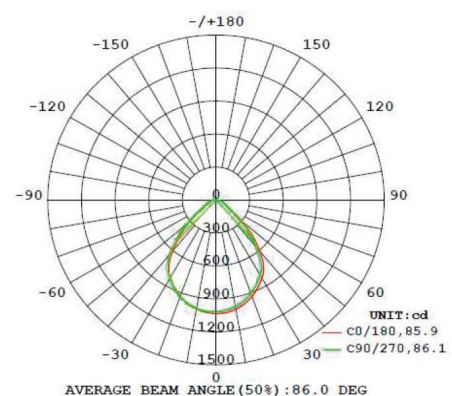

Driver utilizado

TRIDONIC



ThreeLine
TECHNOLOGY